

NTN

NTN BEARING - THAILAND CO.,LTD.

COMPANY PROFILE

Make the world
NAMERAKA



[CORPORATE DATA] NTN BEARING THAILAND COMPANY PROFILE



▶ HEADQUARTERS

Corporate Name :	NTN Corporation
Trademark :	NTN
Founded Date :	March 1918
Capital :	54.3 Billion yen
Head Office :	1-3-17, Kyomachibori, Nishi-ku, Osaka-shi, Osaka, Japan 550-0003
Employees :	5,756 (consolidated:23,383) *as of March 2022
Description of Business :	Manufacture and sale of bearings, driveshafts, and precision equipments

▶ NTN BEARING - THAILAND

Corporate Name :	NTN Bearing - Thailand Co.,Ltd.
Established :	February 1974
Capital :	780 Million Baht
Location :	Head Office (Bangkok) 29 th Floor Panjathani Tower, 127/34 Nonsee Road, Chongnonsee, Yannawa, BANGKOK 10120
Branch :	Khon Kaen Branch Had Yai Branch Chiang Mai Branch
Employees :	74 persons

▶ MILESTONE OF NTN BEARING - THAILAND CO., LTD.

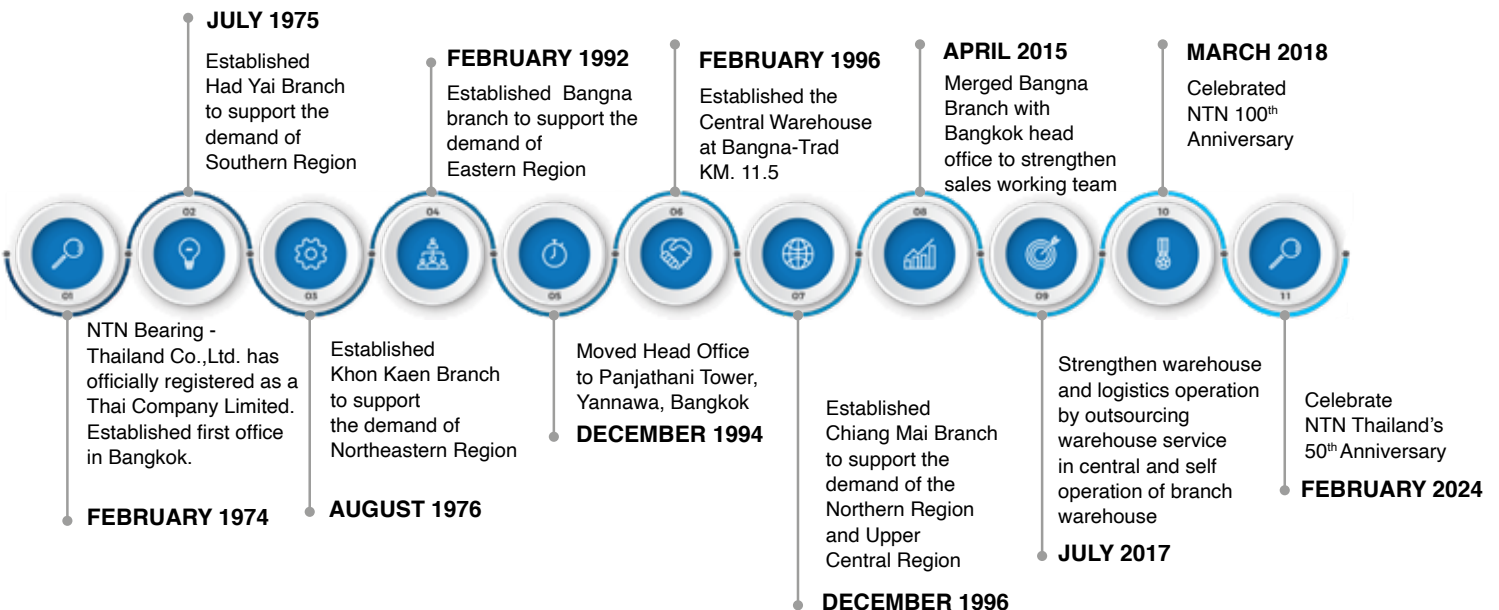

▶ COMPANY GLOBAL NETWORK

- Production Plants
- Sales Office

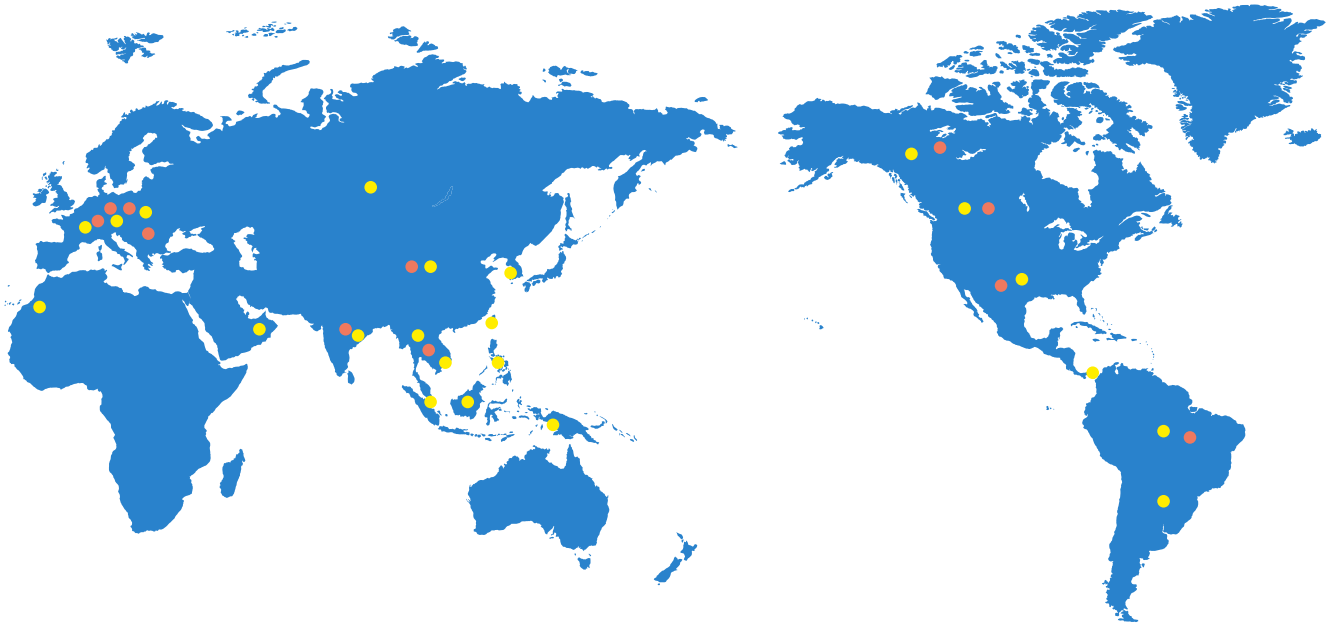

PRODUCTION PLANTS

ASIA AND OCEANIA

- Japan
- China
- Thailand
- Indonesia
- India
- Taiwan

EUROPE AND AFRICA

- Germany
- France
- Italy
- Romania

AMERICA

- U.S.A.
- Brasil
- Canada
- Mexico

SALES OFFICE

ASIA AND OCEANIA

- Japan
- China
- Korea
- Taiwan
- India
- Thailand
- Malaysia
- Singapore
- Indonesia
- Philippines
- Vietnam
- Australia
- UAE

EUROPE AND AFRICA

- Germany
- UK
- France
- Spain
- Italy
- Poland
- Romania
- Russia
- Morocco

AMERICA

- U.S.A.
- Canada
- Panamá
- Brasil
- Mexico
- Argentina



<http://www.ntn.co.th>



Learn More About Product [TH]

[OUR PRODUCTS]

BALL BEARINGS

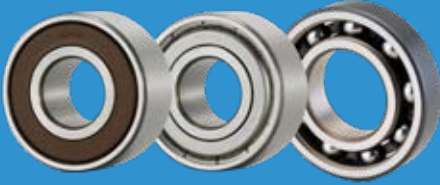

- Deep Groove Ball Bearings
- Angular Contact Ball Bearings
1 & 2 Rows
- Self-Aligning Ball Bearings
- Insert Bearings
- Thrust Ball Bearings

ROLLER BEARINGS



- Cylindrical Roller Bearings
1 & 2 Rows
- Needle Roller Bearings
- Tapered Roller Bearings
1 & 2 Rows
- Spherical Roller Bearings
- Thrust Roller Bearings

HOUSINGS

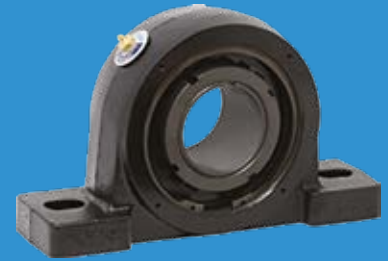

- (Variety of housings, bearing inserts, sealings and materials)*
- Bearing Units
 - Plummer Blocks

OTHER BEARINGS/PRODUCTS



Linear Motion Products : Bearings with Solid Grease, Insulated Bearings, Bearphites, Part Feeders, Hub Bearings, Constant Velocity Joints, Auto Tensioners Clutches

AND MANY MORE...



► **AUTOMOBILE**

ENGINE

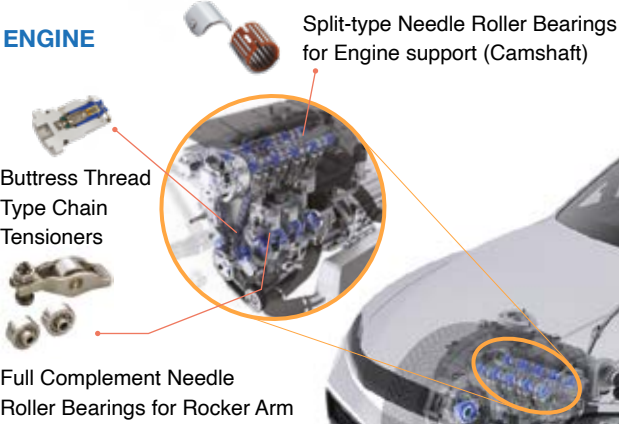

Hub Bearings



Constant velocity joints

AUTOMATIC TRANSMISSION

ACCESSORY

- Sprag Clutches for Stator of Torque Converter
- Long-Life Series TAB Bearings
- ULTAGE Tapered Roller Bearings
- Low Friction Thrust Roller Bearings
- Needle Roller and Cage Assemblies
- Thrust Roller Bearings for Eccentric Rotation

► **MOTORCYCLE**

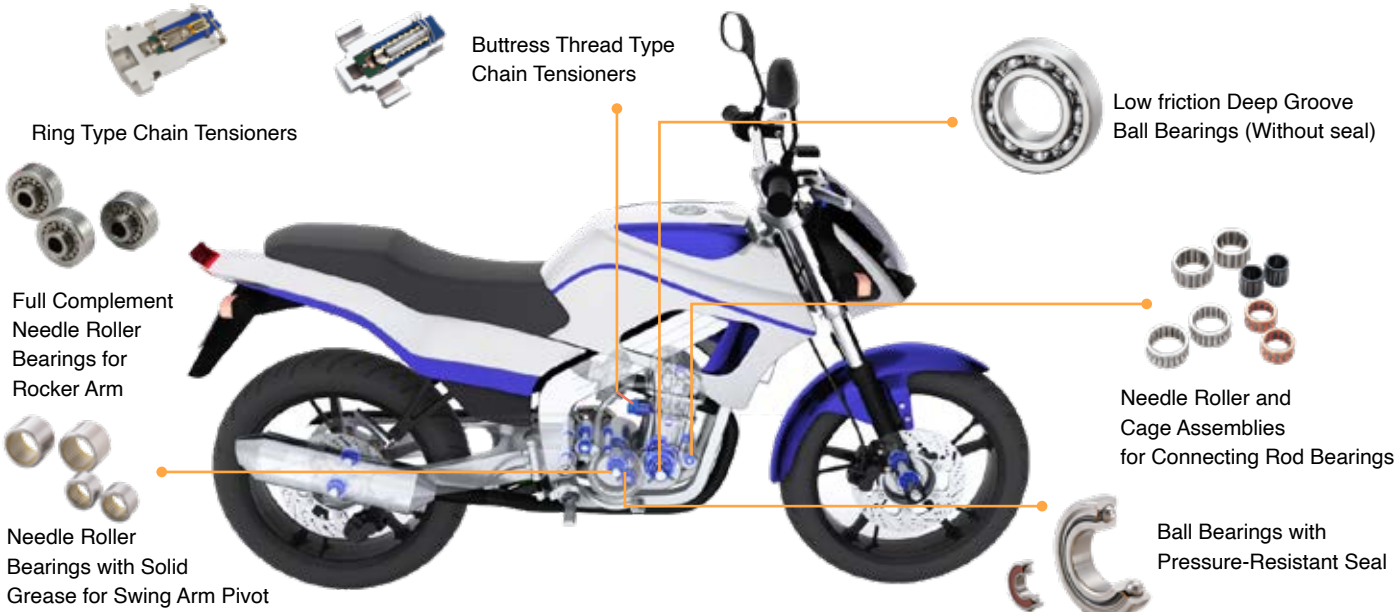

[FOCUS INDUSTRIES]

RAILWAY



TRACTION MOTOR BEARINGS

Optimized cage design
Insulated bearings
(ceramic or polymer insulation)



JOURNAL BEARINGS



Increased service life
Reduced maintenance
Anti-fretting solutions
Optimized cage design
Labyrinth & friction seals
Metric or AAR dimensioning

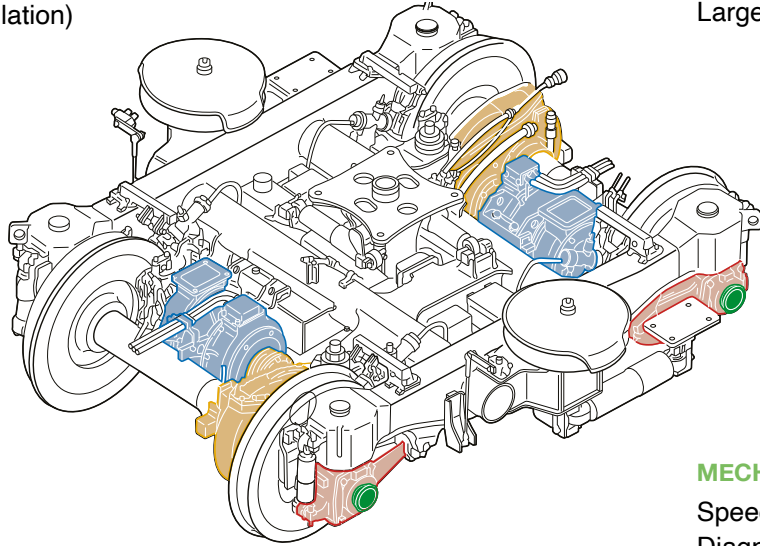

TRANSMISSION BEARINGS

Optimized cage design
Increased load-bearing capacity
Large bearings



MECHATRONIC SOLUTIONS

Speed and temperature sensors
Diagnosis systems
(Condition Monitoring Systems)
Wireless communication

► WIND TURBINE

Wind turbine technology continues to progress for increased efficiency, reliability and longer service life of equipment. Innovative bearing designs from NTN are instrumental in these improvements and in spreading the use of wind technology for electrical power generation. Our products are built with three concepts in mind: harmony with the natural environment, improved energy conservation and contribution to international society.

ROTOR MAINSHAFT BEARINGS



Spherical roller bearings



Cylindrical roller bearings



Double-row tapered roller bearings

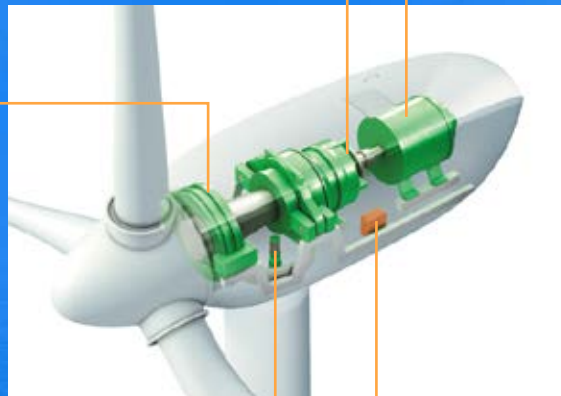

GEARBOX BEARINGS



GENERATOR BEARINGS



Cylindrical roller bearings

YAW GEARBOX BEARINGS

CONDITION MONITORING SYSTEM



Data acquisition module



1 MAIN SHAFTS



Main shaft bearings support high-speed rotation of the engine and are required to have high reliability and strict quality control due to needing to be run with high precision for long periods of time. From material processing to heat treatment, and processing to inspection, our company conducts the highest level of quality control

3 LANDING GEAR



Wheel bearings for landing gear require a design that repeatedly withstands the impact at the time of grounding, rapid acceleration and moment load at taxiing. We supply specially designed tapered roller bearings that suppress the occurrence of excessive surface pressure and are optimized for this application.

2 GEARBOXES



NTN provides the highest quality bearings for gearboxes that drive such things as the generator and various pumps by obtaining power from the engine. The same level of reliability as main shafts is required for gearbox bearings that support gear loading and rotation.

4 FLIGHT CONTROL SYSTEM



NTN supplies bearings of various types and sizes to be used for parts that are extremely important for the aircraft to fly such as flaps, ailerons, and ladders, as well as actuators that control the angle of the aircraft during flight.

[FOCUS INDUSTRIES]

GREEN ENERGY

▶ ELECTRIC VEHICLE

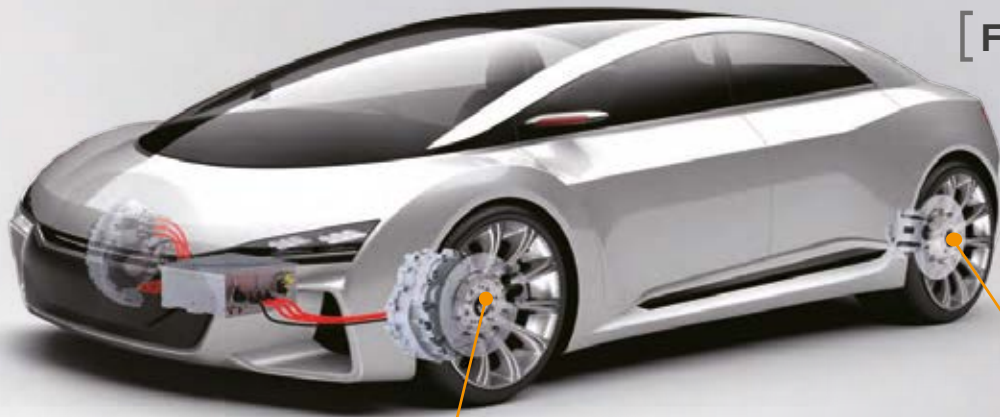

In-Wheel Motor System

Compact and light weight In-Wheel Motor integrated with Parallel shaft gear reducer.



Electromechanical Brake System with Parking Brake

Contributes to improvement of the vehicle safety with high-response and high-accuracy brake control. Included parking brake unit.



Two Motor on-board Drive System*

This system has two motors and can provide the optimum torque to each wheel independently according to vehicle traveling conditions.



Hub bearings and Driveshafts

Hub bearings support the rotation of tires, while driveshafts transmit power from the motor to the tires.

Electric Motor and Actuators Coaxial Hollow Shaft Type BIII



The lineup of the BIII series is available to be mounted directly on components such as engines, transmissions, brakes, etc. To downsize the actuator, components are assembled in the hollow space of SP motor.

Electric Motor and Actuators Parallel Shaft Type BIII



The lineup of BII series is suited to electronic control of brakes, shift controls and other similar applications.

Grease Lubrication Type High Speed Deep Groove Ball Bearings for EV/HEV

EV and HEV seal type deep groove ball bearing corresponds to speed of dmn value 1.08 million, because resin cage has optimized material and shape and greases has improved lubrication under high speed.

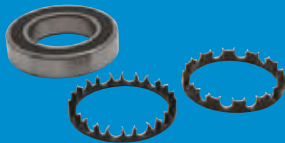

High Speed and Low Friction Deep Groove Ball Bearings for EV/HEV

Deep groove ball bearings for EV and HEV motors as well as reduction gear – special retainer design of the bearing enables a reduction in lubricant stirring drag, which leads to super low friction, while allowing high speed rotation (DN value of 1.6 million).



*Please note that the contents of products under development are subject to change without notice.

▶ GREEN ENERGY PRODUCTS

NTN is developing businesses in the natural energy field by integrating the technology and knowhow include NTN vertical axis wind turbines, NTN Green Power Station, and NTN micro hydro turbines that utilize highly efficient blade technology to generate electricity from less natural energy.

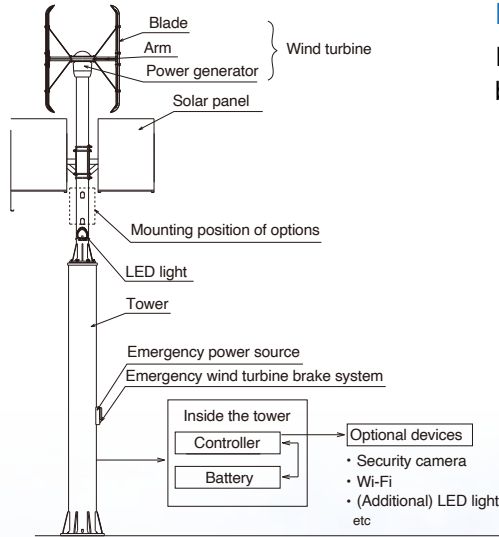

NTN GREEN POWER STATION

Independent power supply that generates electricity by solar & wind to promote safer communities.

- Wide range of options
 - Security camera
 - Wi-Fi
 - Clock
 - Guide plate
 - Banner advertisement
 - Color of the tower and/or blades
 - Original sticker
 - Additional batteries
 - Additional LED lights



“N³ N-CUBE”

“N³ N-CUBE”, a next-generation Container Type Transportable Independent Power Supply that can generate and supply electricity from three types of natural energy (wind, water, and solar light) in a short time by mounting power generators and storage batteries in a container.

It can quickly generate electricity in the event of disaster and recharge smartphones using USB ports and other devices, and people can use small home appliances.

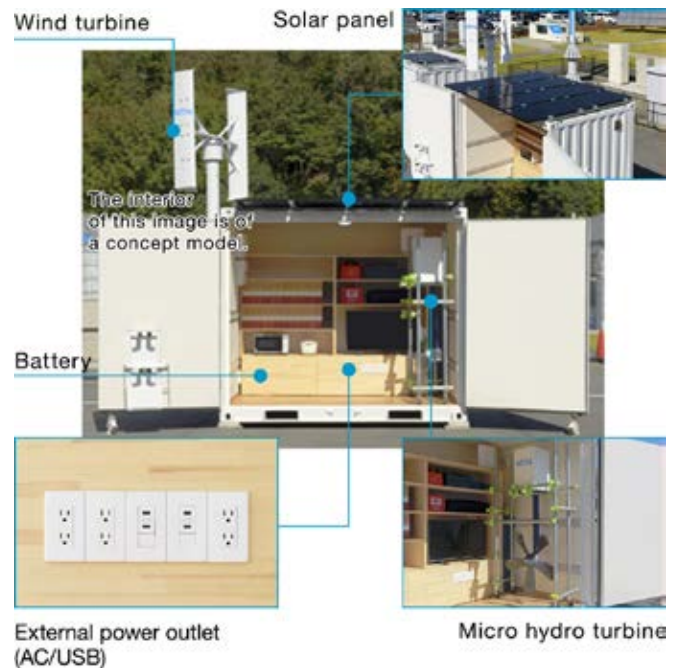

[FOCUS INDUSTRIES]

HEAVY INDUSTRIES

► CEMENT PLANT

NTN is contributing to the production of high-quality cement. By providing products suited to service life under dust, high-load and high-temperature environments, which contributes to reductions in maintenance costs.

VERTICAL ROLLER MILL COAL PULVERIZERS

Double-Row Tapered Roller Bearing
Cylindrical Roller Bearing

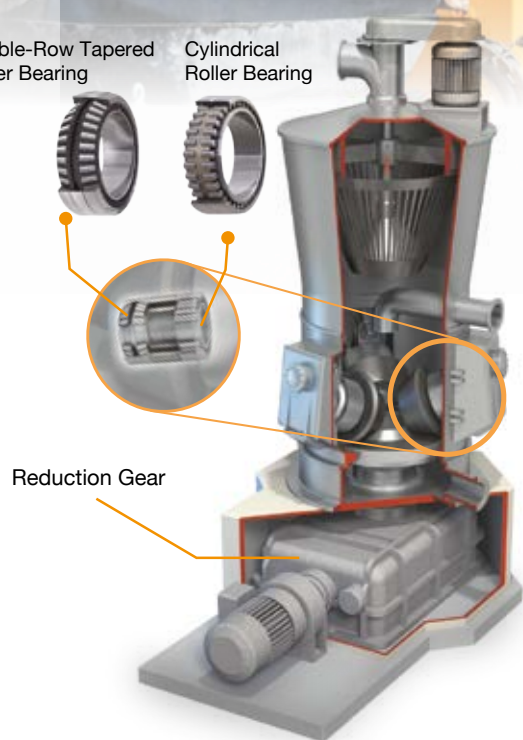

Reduction Gear

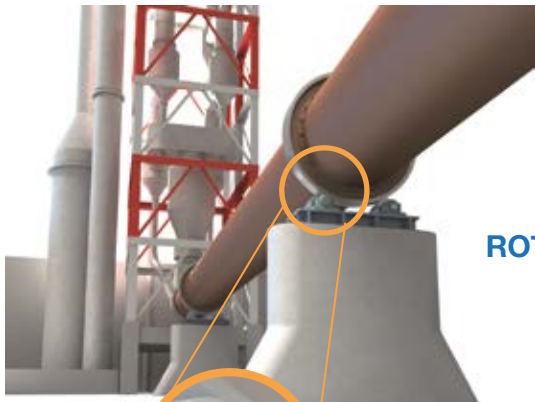

ROTARY KILNS

VIBRATING SCREENS



Plummer Block

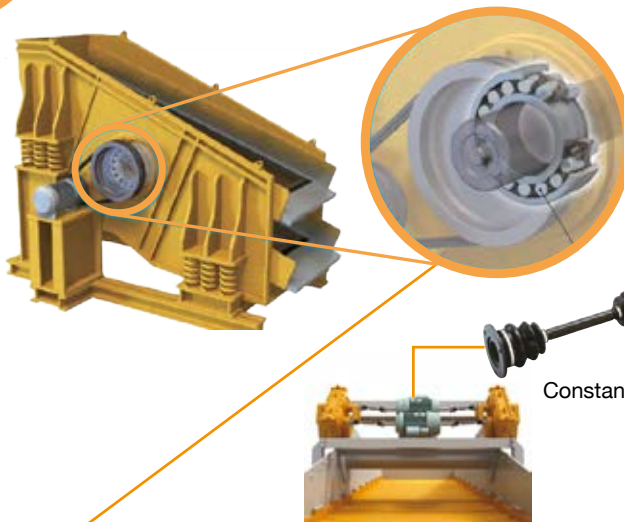

Constant velocity joints

REDUCER BALL MILL

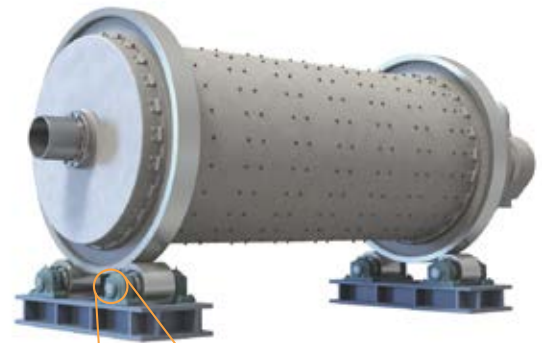

Plummer Block

ULTAGE™

LONG LIFE

- Larger rollers provide the industry's highest load capacity
- Extended maintenance intervals
- Withstands operating temperatures up to 200 °C

HIGHER ROTATIONAL SPEED

- The industry's highest allowable rotational speed
- Simple window-type configuration employs a pressed steel cage
- The back face of the cage provides roller guidance and eliminates the need for a guide ring

EASIER HANDLING

- Unique structure readily accepts lubricant
- Easy application of grease



Long life and Higher speed operation

Vibratory conveyors

Ultage Sealed Spherical Roller Bearing



Tail Pulley:
Plummer Blocks



Head Pulley:
Lubrication
Plummer Blocks



[FOCUS INDUSTRIES]

HEAVY INDUSTRIES

► MINING & MINERAL APPLICATION

Transferring Rollers:
DGBB with low friction seal
(Bearing Units)



(Bearing Units)

Bend Pulley:
SRB with adapter sleeve
(Plummer Blocks)

Tension Pulley:
Plummer Blocks
(Ultage Sealed SRB)



The bearings used in mining machinery are often operating under extreme conditions such as heavy load, dust, water, etc.. NTN provides a premium product, designed to handle the rigors of mining, often resulting in longer operating life and extended maintenance cycles.

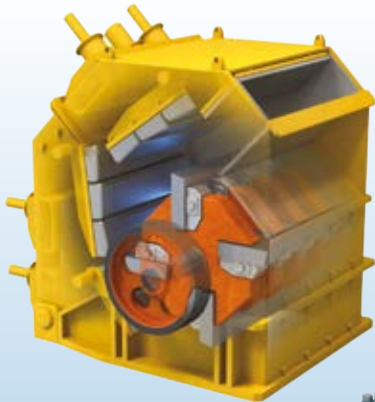

Impact crushers



Cone crushers



Constant velocity joints



Tapered roller bearings



Plummer blocks

Triple-lip sealed bearings for bearing units

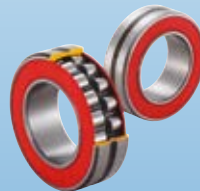

ULTAGE series sealed spherical roller bearings [Type WA]



SL type cylindrical roller bearings for sheaves

Bearing units

Type EA

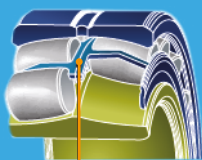

Window-Type Pressed Steel Cage

Type EM



One-Piece Machined Cage

Type EM (LARGE SIZE)

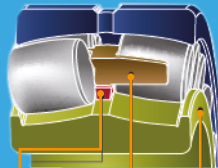

Guide Ring
Inner Ring Rib
One-Piece Machined Cage

Type EMA



High-Strength Cage

Type WA



ULTAGE Series Sealed Spherical Roller Bearings

[FOCUS INDUSTRIES]

HEAVY INDUSTRIES

► CONSTRUCTION MACHINERY

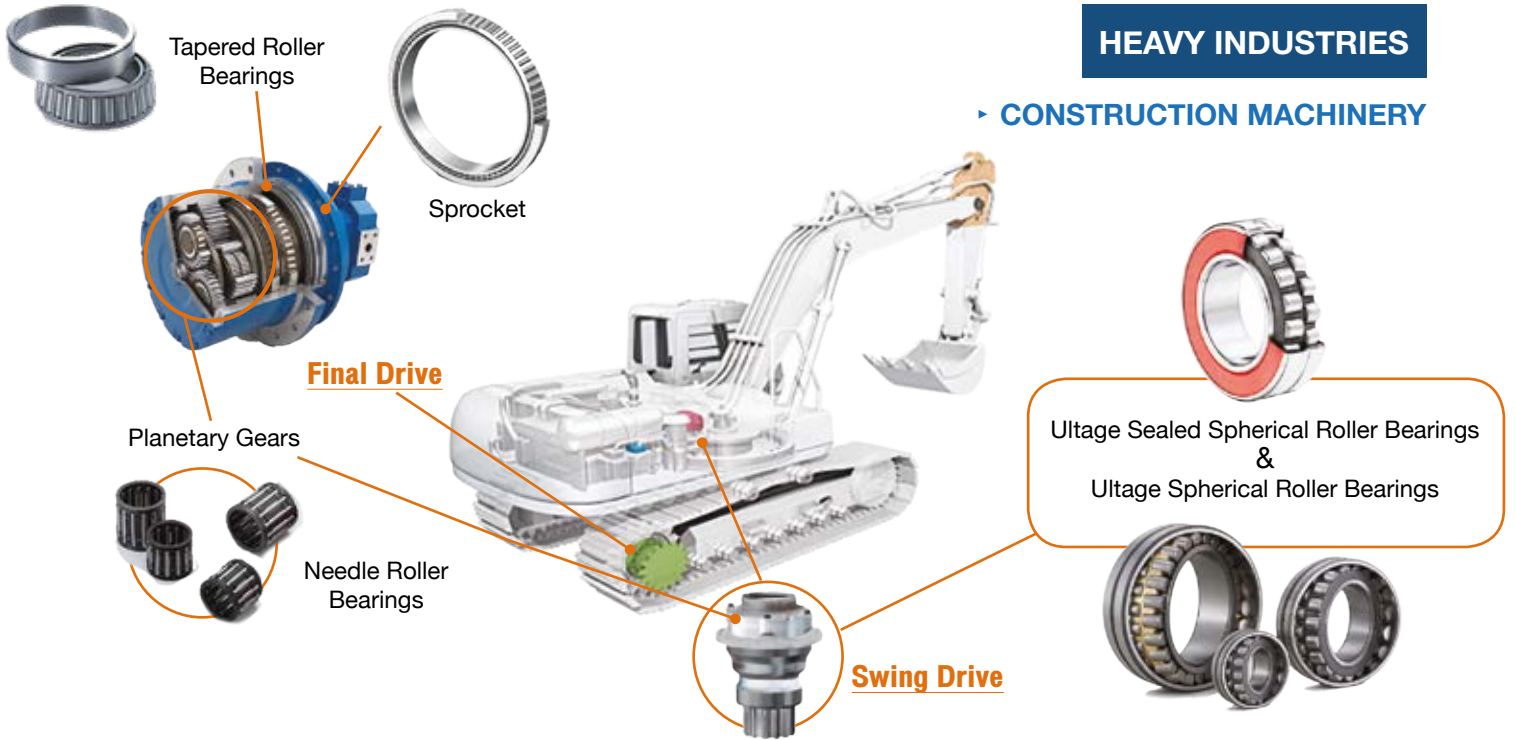

► TRACTOR



SELF PROPELLED MACHINES

Variety of Housings for:

- Screw Conveyor
- Foldable Grain Header
- Roller Support

Tapered Roller Bearings

- Disc harrowing
- Soil working

Double Row Ball Bearings

- Forage - Cutting Bars

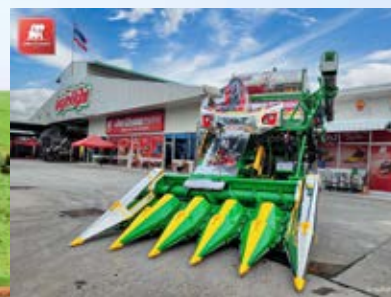

[FOCUS INDUSTRIES]

HEAVY INDUSTRIES

► PAPER MAKING

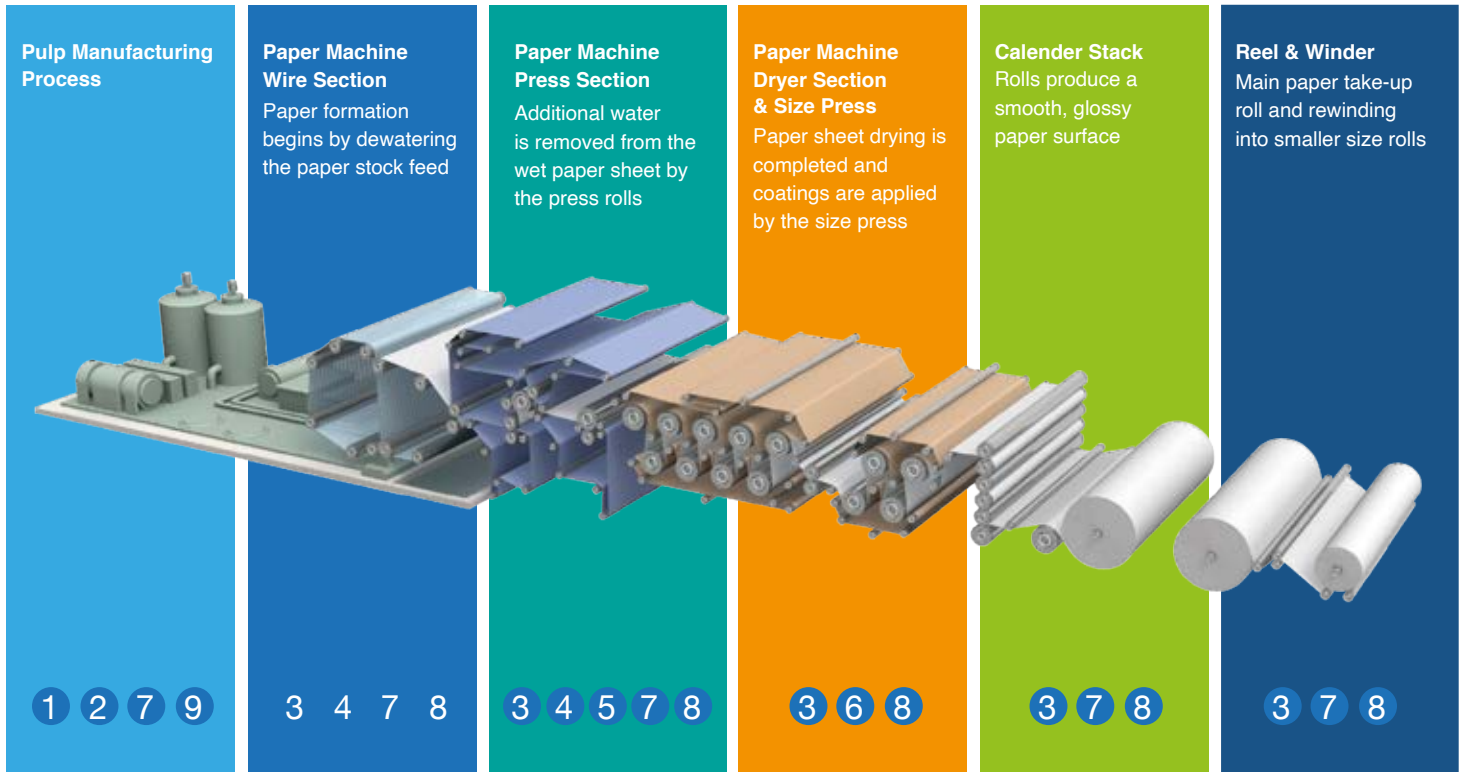

1
ULTAGE series sealed spherical roller bearings [Type WA]



2
ULTAGE series thrust spherical roller bearings



3
ULTAGE series spherical roller bearings [Type EA, Type EM]



4
RustGuard corrosion-resistant bearings



5
MEGAOHM™ insulated bearings



6
Long operating life EA bearings



7
Solid grease bearings



8
Constant velocity joint



9
Triple-Lip sealed bearings for bearing units

[FOCUS INDUSTRIES]

HEAVY INDUSTRIES

► STEEL MANUFACTURING

NTN support high load capacity, long operating life, easy handling



SINTERING EQUIPMENT

Split spherical roller bearings

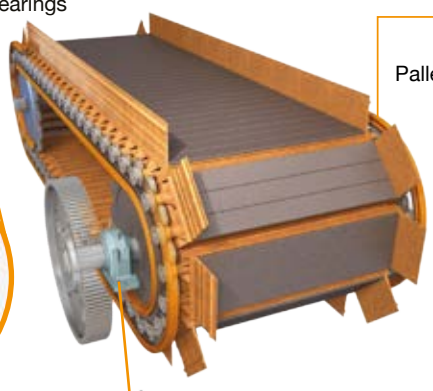
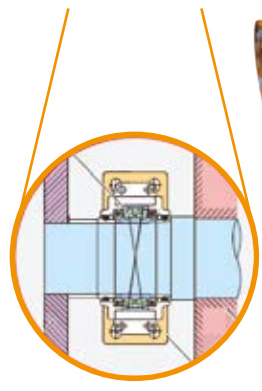

Ultra-Large Split Spherical Roller Bearings

CONTINUOUS CASTING MACHINES

Hot rolling machinery

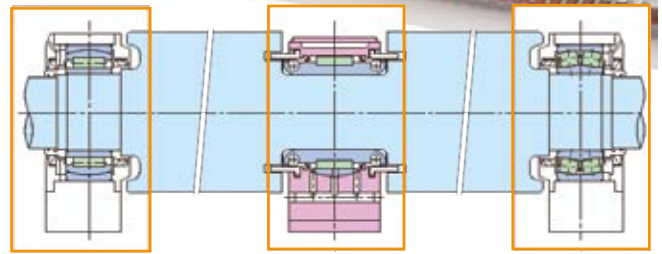
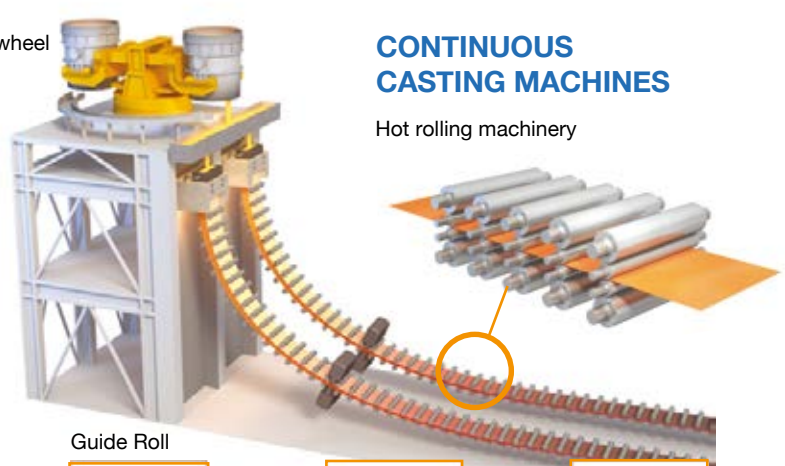

CONVERTERS

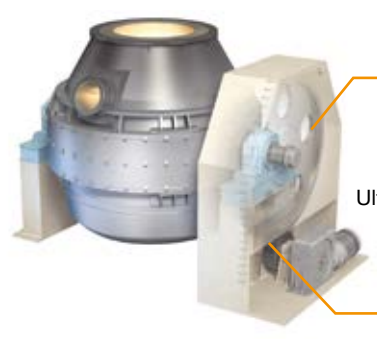

Ultra-Large Split Spherical Roller Bearings



MAKE THE WORLD NAMERAKA

ROLLING MILL EQUIPMENT

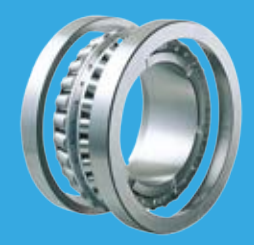

BEARINGS FOR THRESHER DRUM & (FFB) FRUIT PALM FERTILIZER BOGIE CAGE WHEELS

Thresher Drum FFB Cage Wheels Screw Press



Thresher Drum



Ultage Spherical Roller Bearing



FFB Cage Wheels

SCREW PRESS



Ultage Thrust Spherical Bearing



Ultage Spherical Roller Bearing

► **SUGAR REFINING MILL**

1. Cane Transfer & Shredder
2. Milling Train
3. Boiler & Clarifier
4. Crystallisation & Separation
5. Centrifugals & Driers
6. Packing & Storage



Bearing with Solid Grease



Ultage Spherical Roller Bearing



Tapered Roller Bearing



Cane Transfer & Shredder



Milling Train



Boiler & Clarifier

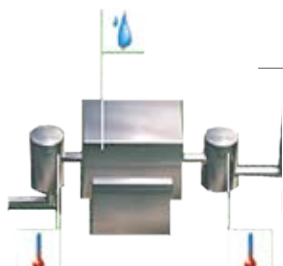

Crystallisation & Separation



Centrifugals & Driers



spin-dryer



Packing & Storage



Bearing Unit

[FOCUS INDUSTRIES]

AGRICULTURAL MACHINERY

▶ FOOD MACHINERY



Bearing Units Stainless Steel Series



Bearing Units Plastic Series

NTN FOOD MACHINERY PRODUCTS :

- Employs food grade heat solidifying grease to reduce lubricant leakage
- Uses food grade grease compliant to USDA H-1 standard
- Can be dustproof/waterproof to ensure longer service life

STAINLESS STEEL BEARING UNITS SERIES

- Greater corrosion resistance
- Smooth surface which attracts minimal amount of foreign matter

PLASTIC BEARING UNITS SERIES

- Free of peeling paint and rusting



Triple-Lip Sealed Bearings for Bearing Units



Solid Grease Bearings

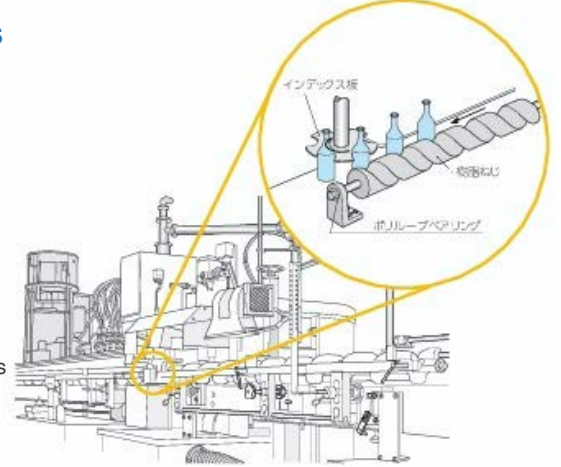

▶ RUBBER BLOCK & GLOVES



Shredder



Ultage Spherical Roller Bearing



Hammer-Mill



Slab-Cutter



Crapper



PLUMMER BLOCKS

- High sealing performance
- Vibration resistance
- Sufficient bolt tightening force against vibration and shock
- Fitted with re-lubricating hole
- Easy to lubricate
- Various seal types e.g Rubber seal, Felt seal, S-shape seal, Labyrinth seals.
- Specially-coated housing are also available



PRECISION EQUIPMENTS

Recently, the robotics market has become very active, and demand is expanding each and every day.

Various types of mechanical equipment, such as reduction gears, are incorporated into robotics, and many bearings are used. NTN manufactures a wide variety of bearings for robotics applications.

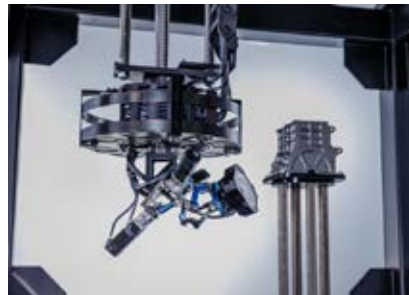
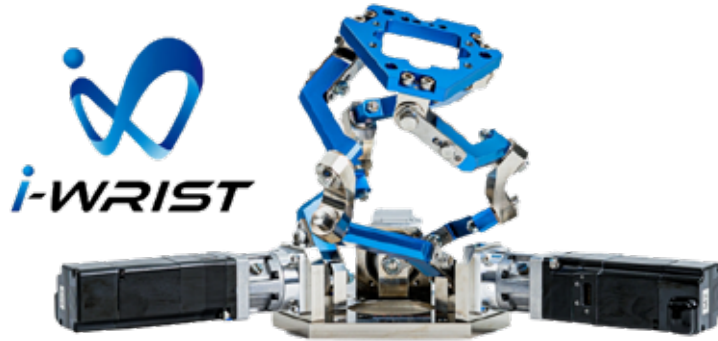

NTN has developed the angle control equipment applying a parallel link mechanism which is a type of constant velocity joint. In order to expand this equipment for appearance inspection application, we expanded the movable bending angle range from 45° to 90° and developed a wrist joint module which can be positioned toward any posture in all hemispherical directions at high speed.



Part Feeder

NTN Parts Feeders can automatically align a wide variety of work pieces (such as machine parts, electronic parts, plastic parts, chemicals, pharmaceuticals, foods, and miscellaneous goods), and feed them via a vibratory trough for processing in automated production machines.

And many more



Electro spindle

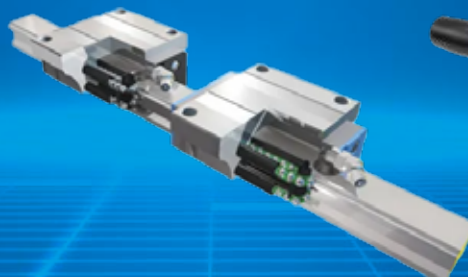

Linear Motion

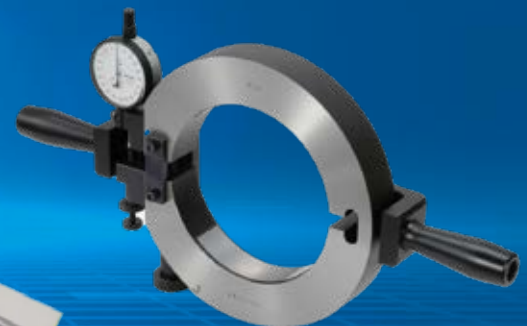

High-speed electric spindle technology

[FOCUS INDUSTRIES]

OTHERS



TEXTILE



ROBOTIC



ENERGY



MEDICAL EQUIPMENT



OFFICE EQUIPMENT



MACHINE TOOL



AIR CONDITIONER



INDUSTRIAL / ELECTRIC MACHINE

- PUMPS
- FANS
- MOTORS



[MAINTENANCE TOOLS]

Experts & Tools offers you the complete set of tools and services to increase the working life of your bearings. These products will save time and trouble during maintenance operations while avoiding causes of premature failure of your bearings.



▶ HYDRAULIC DISMOUNTING

Hydraulic Nut,
Manual Hydraulic Pump Kits



▶ COLD MOUNTING

Mounting Tool Kit, Anti-Fretting Paste,
Adjustable Spanner



▶ MECHANICAL DISMOUNTING

Puller Kit, Bore Puller,
Mechanical Puller



▶ HOT MOUNTING

Induction Heater,
Heat-Resistant Gloves



▶ HYDRAULIC MOUNTING

Hydraulic Push-Puller,
Hydraulic Nut,
Manual Hydraulic Pump Kit

▶ VIBROSCOPE

NTN Portable Vibroscope is a device that can measure facility vibrations, and detect abnormalities and damaged positions of bearings. It can be used simply by attaching to the facilities with magnets, screws, etc. Vibration data can be analyzed and managed with Apple iOS smart devices installed the dedicated application.



To use this system,
you need to prepare
iPhone or iPad.

[NTN ENGINEERING SERVICE]

▶ CARAVAN SERVICES & ENGINEERING SUPPORT



▶ EXHIBITION





Make the world **NAMERAKA**

Head Office

29th Floor Panjathani Tower,
127/34 Nonsee Road,
Chongnonsee, Yannawa,
Bangkok 10120
Phone : +66 (0) 2681 0401-8
Fax : +66 (0) 2681 0409,
+66 (0) 2681 0196

Khon Kaen

189-191 Ruen Rom Road,
Nai-Muang, Amphur Muang,
Khon Kaen 40000
Phone : +66 (0) 43 222 237,
+66 (0) 43 223 679
Fax : +66 (0) 43 223 061

Chiang Mai

208 (Room B3-B4) Center
Outer Ring Road,
Nong Hoi, Amphur Muang,
Chiang Mai 50000
Phone : +66 (0) 53 142 571-2
Fax : +66 (0) 53 142 573

Had Yai

156/101 - 102 Lopburi-Ramet
Road, Klong Hae,
Amphur Had Yai, Songkhla
90110
Phone : +66 (0) 74 292 651-4
Fax : +66 (0) 74 292 656